

Compact® Side-by-Side Tissue Dispenser specification and mounting sheet

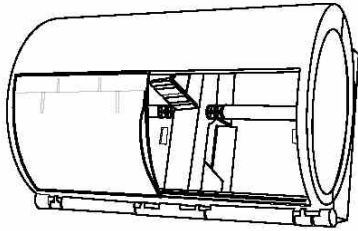

Product Loading Instructions:

1. With cover opened, move spindle system downward.

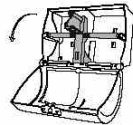

2. Place rolls onto spindles so tissue dispenses from top.

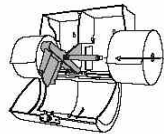

3. Close cover when finished.

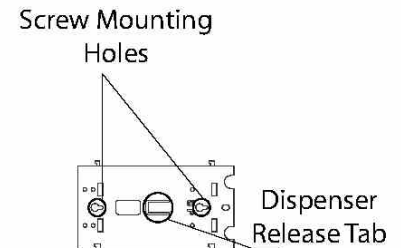
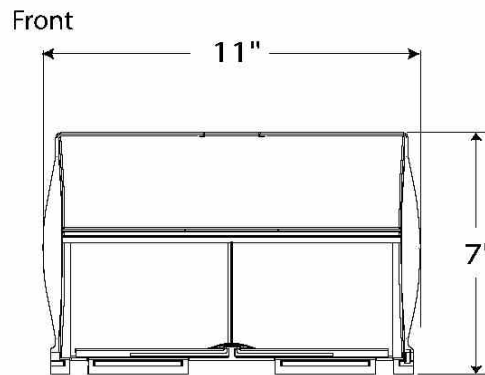
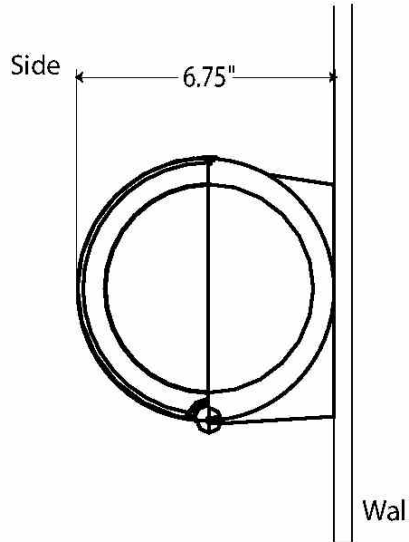
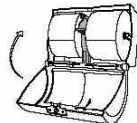

20.5" Minimum

Floor

GP SKU 54019 Mounting Bracket
(not included with dispenser)

Overall Dimensions:

Dispenser: 11" W x 7" H x 6.75" D

Overall Weight:

Dispenser: 1.6 lbs (0.7kg)

Capacity: 2 rolls of Compact 2-ply coreless bath tissue.

Specifications:

The cover of the dispenser is constructed of low maintenance, impact resistant polymer materials.

For questions or comments, please call
1-866-HELLO GP (435-5647)